

POLAR FRANCE - LE TRAITEMENT DE L'EAU

C300VB



C300VB

EAN13: 3586299102924

COLLECTIF

CHAUFFAGE AIR X BOUE - COMBI

COMBI AIR BOUE



ACCÈS RAPIDE:

VIDEO



DOC



DESCRIPTION:

COMBI AIR GAZ BOUE DN300 VISITABLE A BRIDES

ELIMINE BULLE BRUIT GAZ CORROSIF ET CAPTE BOUES IMPURETES >5MIC

GARANTI 20 ANS - SYSTEME POLAR

Assure la protection et la longévité de l'installation



POLAR FRANCE - LE TRAITEMENT DE L'EAU C300VB

INFO SUP.:

SPECIAL CLIMATISATION, PAC REVERSIBLE

DEBIT:

min-max: 0.00 - 405.00 m3/h

RACCORDEMENT:

300

PRESSION (PN):

10 bar

TEMPERATURE:

min-max (°C):110

POIDS:

487,2 kg

INTERVAL D'ENTRETIEN:

PURGE PAR VANNE 1 FOIS PAR MOIS



POLAR FRANCE - LE TRAITEMENT DE L'EAU C300VB

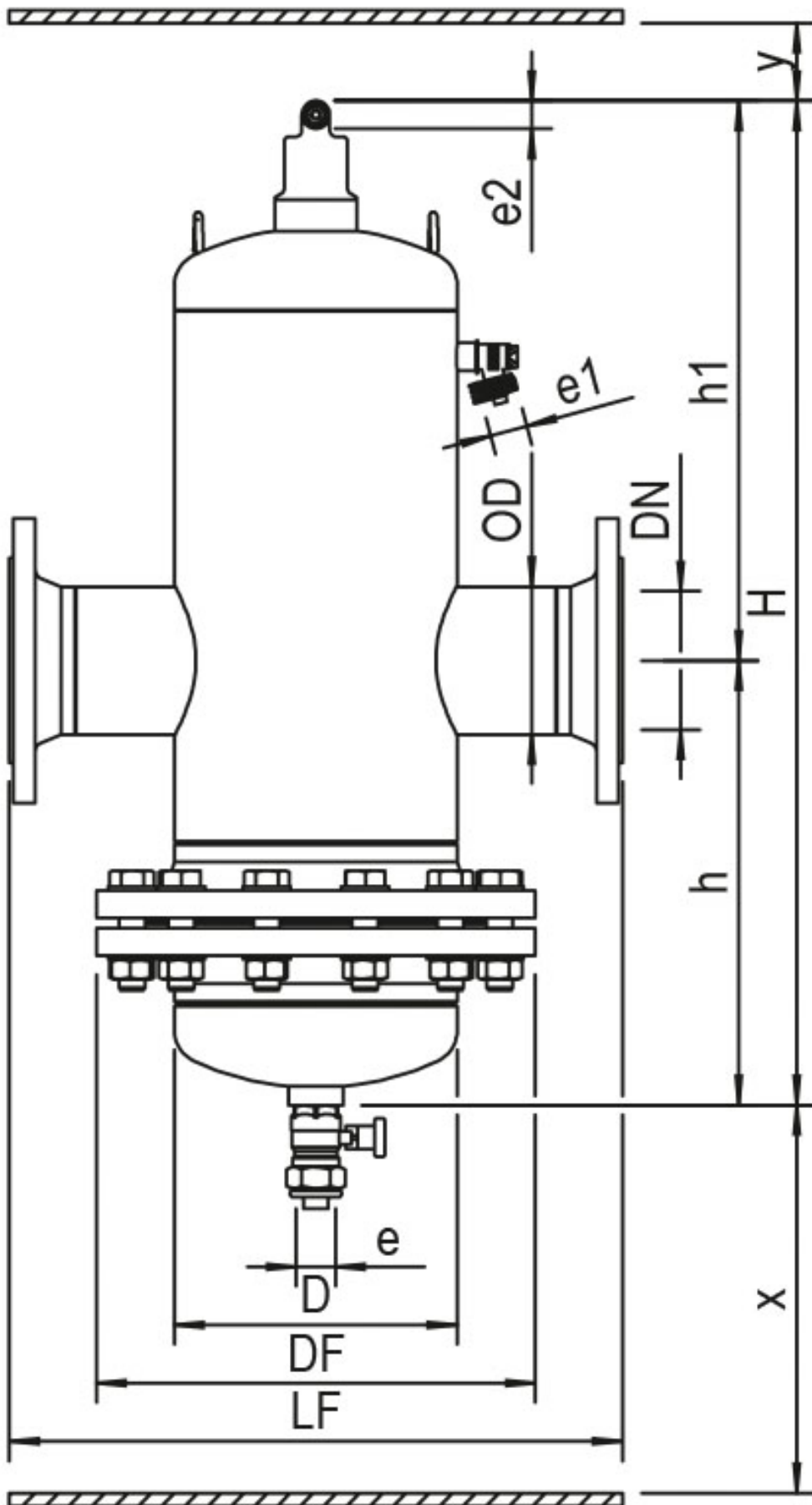

POLAR FRANCE - LE TRAITEMENT DE L'EAU C300VB

