

# POLAR FRANCE - LE TRAITEMENT DE L'EAU

## C65VB



### C65VB

EAN13: 3586299103006

COLLECTIF

CHAUFFAGE AIR X BOUE - COMBI

COMBI AIR BOUE



ACCÈS RAPIDE:

VIDEO



DOC



DESCRIPTION:

COMBI AIR GAZ BOUE DN65 VISITABLE A BRIDES

ELIMINE BULLE BRUIT GAZ CORROSIF ET CAPTE BOUES IMPURETES >5MIC

GARANTI 20 ANS - SYSTEME POLAR

Assure la protection et la longévité de l'installation



# POLAR FRANCE - LE TRAITEMENT DE L'EAU C65VB

## INFO SUP.:

SPECIAL CLIMATISATION, PAC REVERSIBLE

## DEBIT:

min-max: 0.00 - 20.00 m3/h

## RACCORDEMENT:

65

## PRESSION (PN):

10 bar

## TEMPERATURE:

min-max (°C):110

## POIDS:

37,8 kg

## INTERVAL D'ENTRETIEN:

PURGE PAR VANNE 1 FOIS PAR MOIS



# POLAR FRANCE - LE TRAITEMENT DE L'EAU C65VB

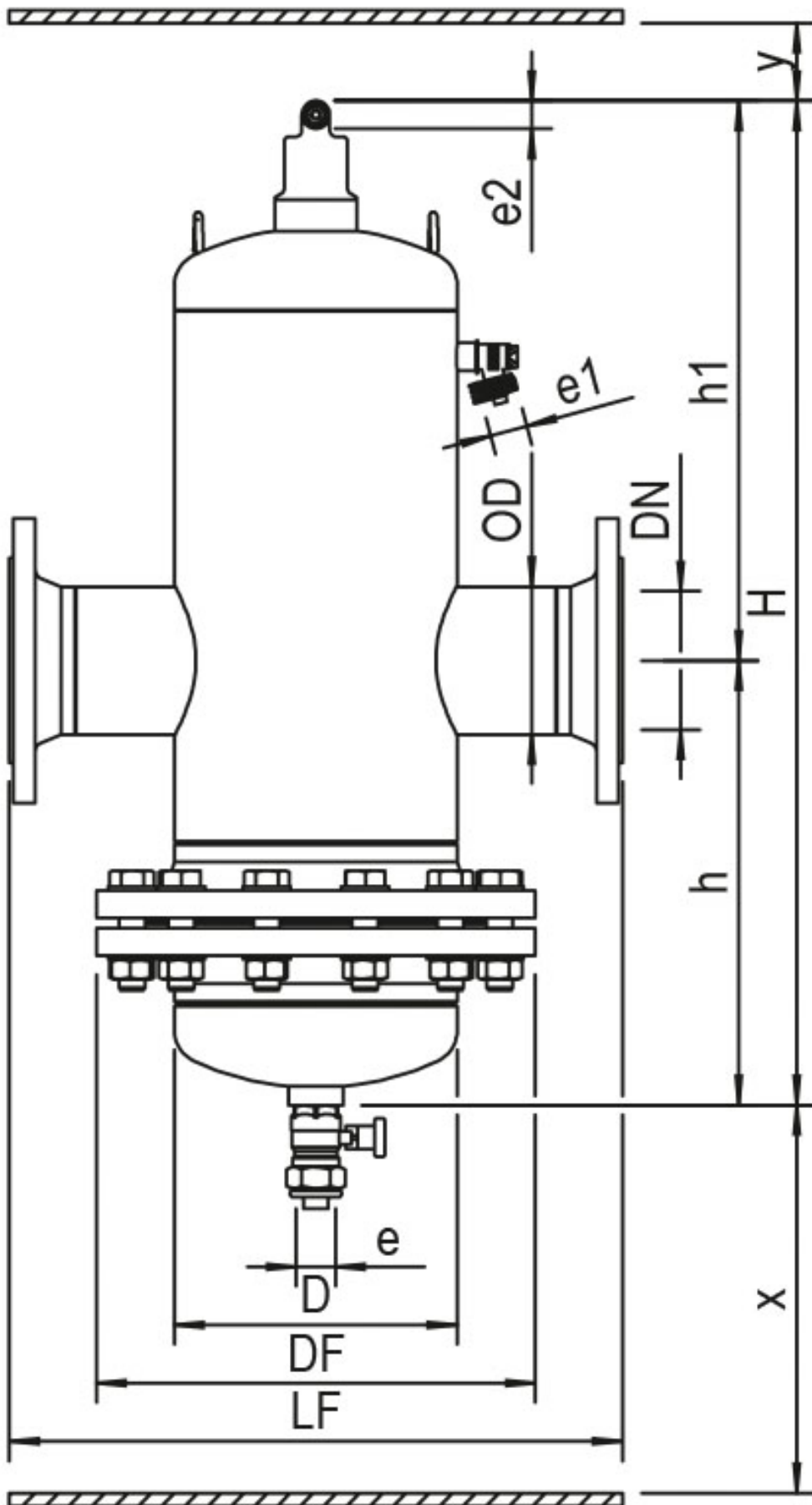

# POLAR FRANCE - LE TRAITEMENT DE L'EAU C65VB

